

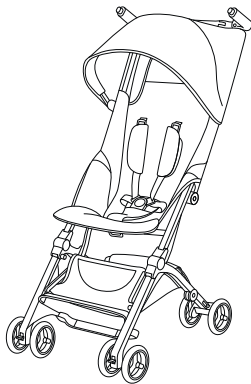













POCKIT+











FUTURE PERFECT



	PREPARING THE POKKIT+	6
	ADJUSTING THE SEAT POSITION	8
	COMPACT FOLD	9
	ULTRA COMPACT FOLD	11
	USING THE HARNESS SYSTEM	12
	USING THE BRAKE	15
	USING THE SWIVEL LOCKS	16
	USING THE RAIN COVER	17
	ATTACHING THE INFANT CAR SEAT	18
	REMOVING THE FABRIC	21/23
	ATTACHING THE COT TO GO	22

	VORBEREITUNG DES POCKIT+	6
	EINSTELLEN DER RÜCKENLEHNE	8
	KOMPAKTE POSITION	9
	ULTRA KOMPAKTE POSITION	11
	VERWENDUNG DES GURTSYSTEMS	12
	BENUTZUNG DER BREMSE	15
	FESTSTELLEN DER VORDERRÄDER	16
	VERWENDUNG DES REGENVERDECKS	17
	ANBRINGEN DER BABYSCHALE	18
	ABNEHMEN DER BEZÜGE	21/23
	ANBRINGEN DES COT TO GO	22

	PREPARAR EL POCKIT+	6
	AJUSTE DEL RESPALDO	8
	PLIEGUE COMPACTO	9
	PLIEGUE ULTRA COMPACTO	11
	USO DEL SISTEMA DE ARNESES	12
	USO DEL FRENO	15
	USO DEL BLOQUEO DE DIRECCIÓN DE LAS RUEDAS DELANTERAS	16
	USO DE LA BURBUJA DE LLUVIA	17
	COLOCACIÓN DEL ADAPTADOR DEL PORTABEBÉS	18
	RETIRAR LA VESTIDURA DEL POCKIT+	21/23
	ADAPTACIÓN DEL COT TO GO	22

	PRÉPARATION DU POCKIT+	6
	RÉGLAGE DU DOSSIER	8
	PLIAGE COMPACT	9
	PLIAGE ULTRA COMPACT	11
	UTILISATION DU HARNAIS	12
	UTILISATION DU FREIN	15
	UTILISATION DU VERROU DE ROTATION	16
	UTILISATION DE L'HABILLAGE PLUIE	17
	INSTALLATION DES ADAPTATEURS POUR COQUE	18
	RETIRER LA HOUSSE DU SIÈGE LUXE	21/23
	ATTACHER LA COT TO GO	22

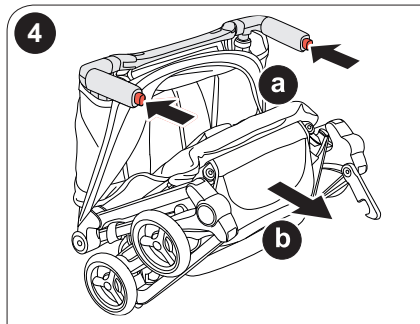
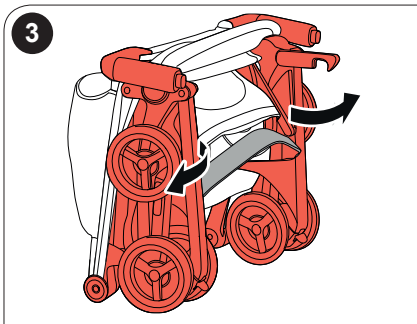
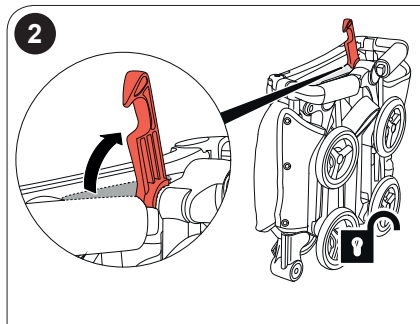
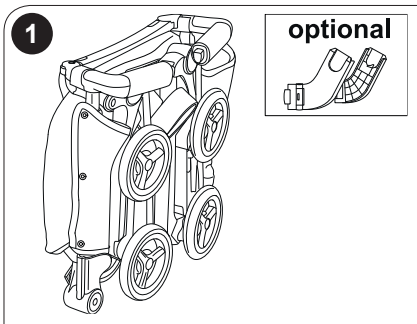

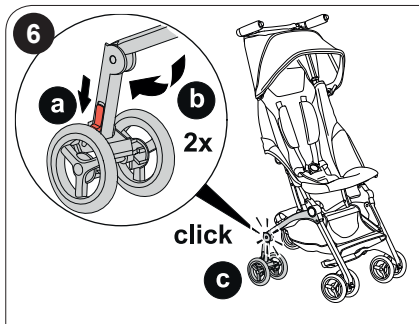
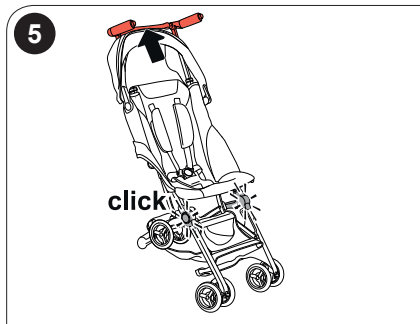

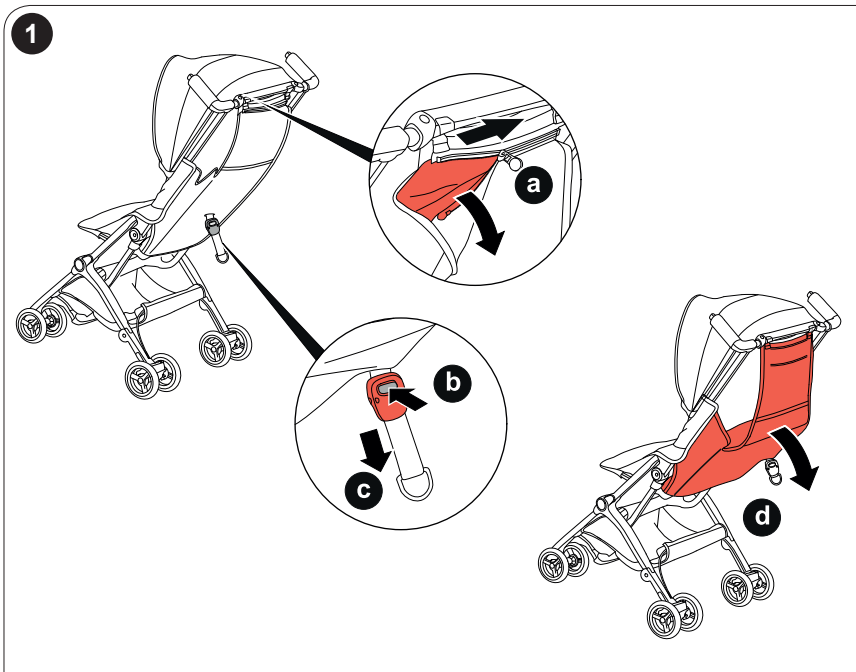

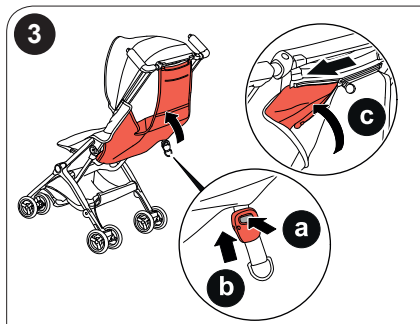
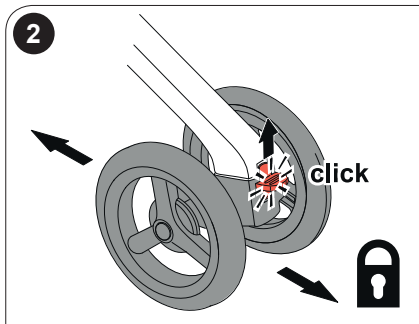
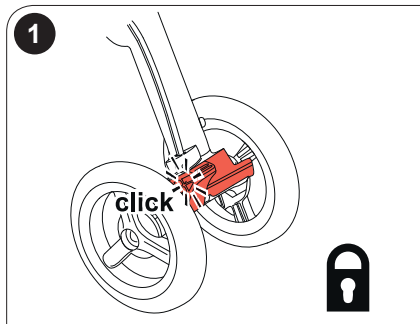

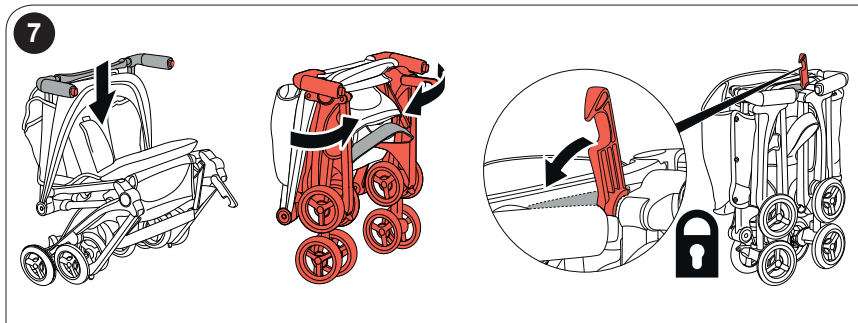
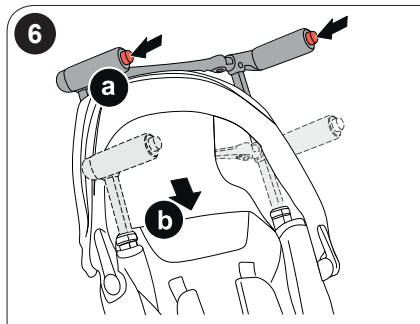
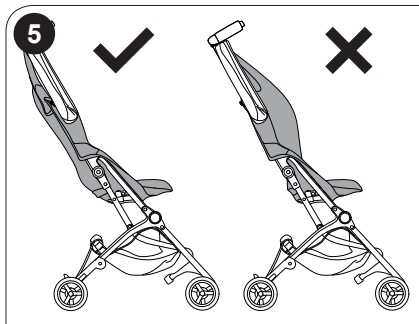

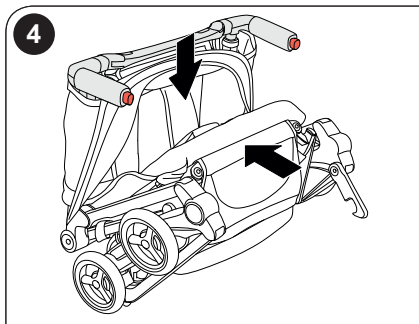
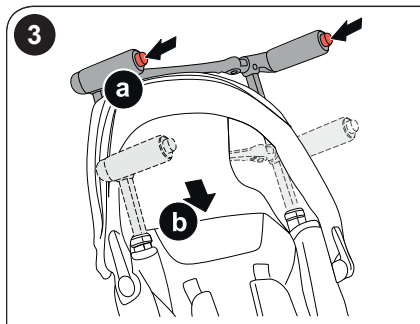
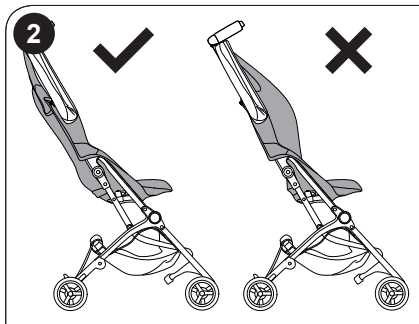
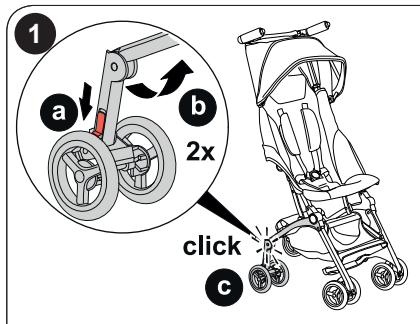

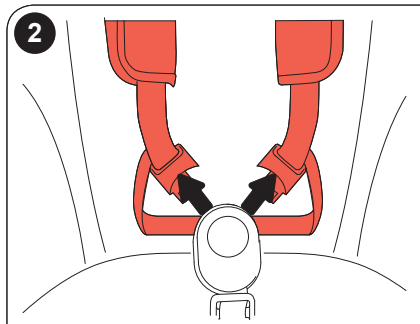
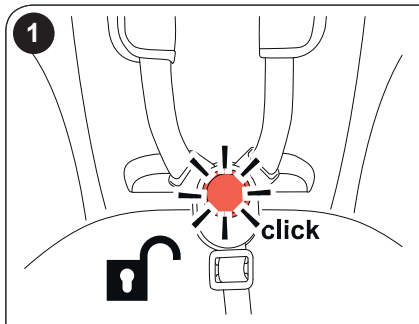
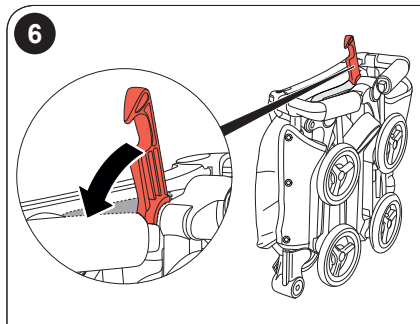
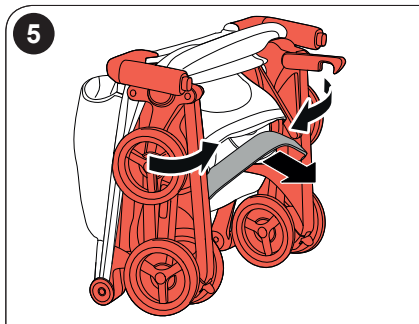

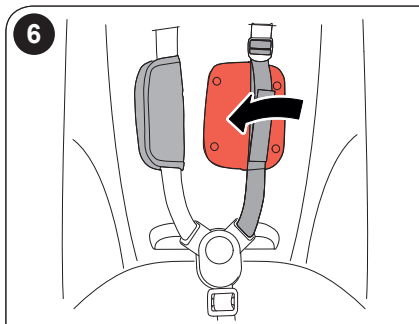
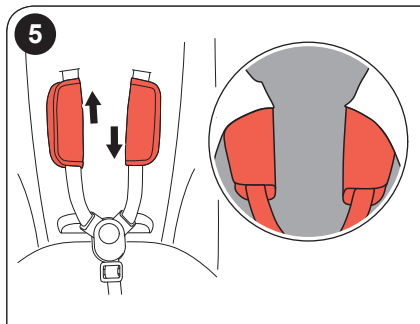
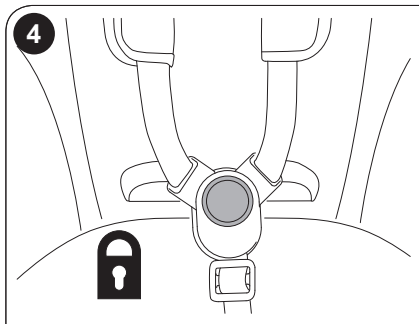
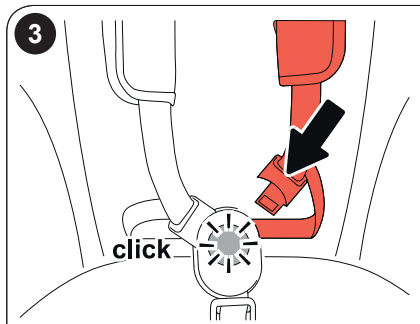

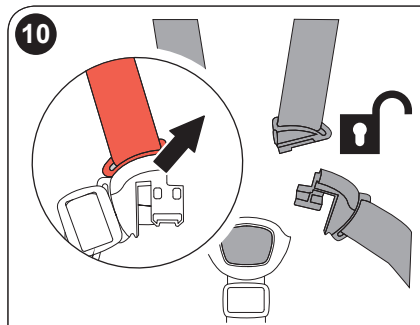
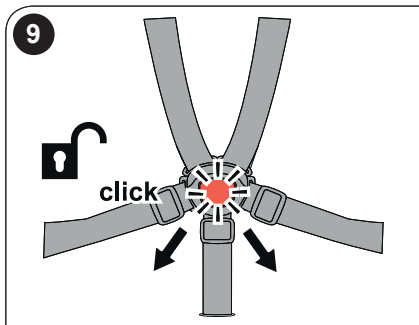
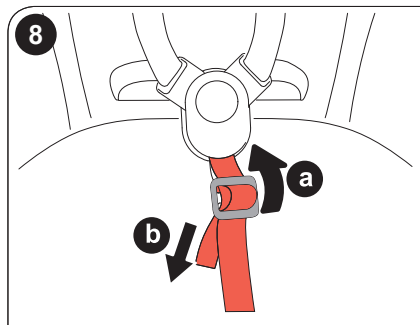
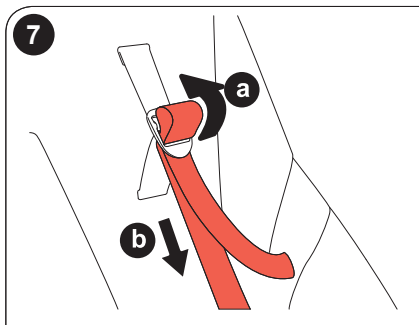

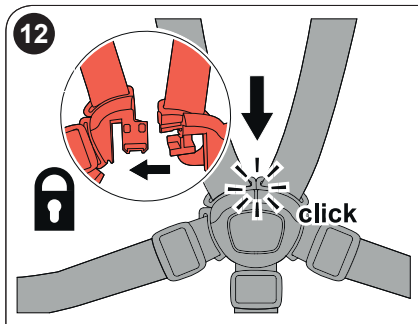
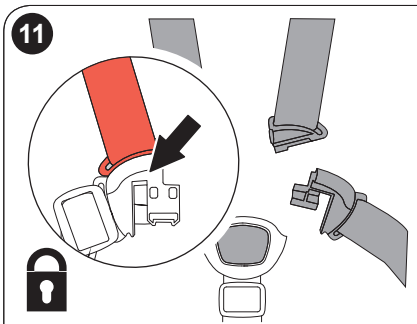

AUS

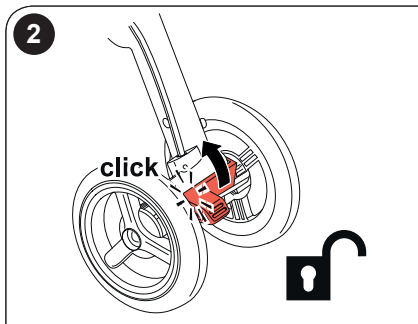
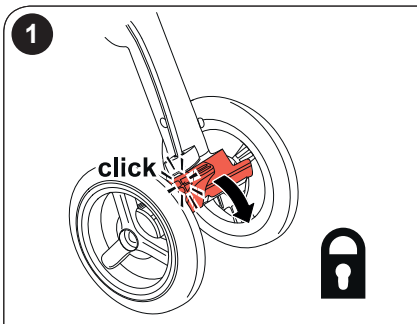

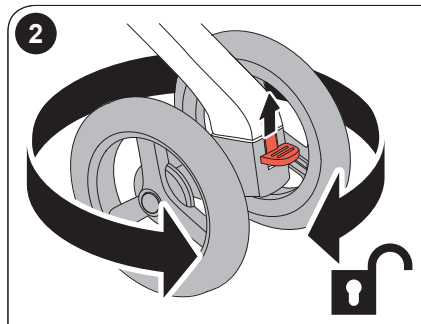
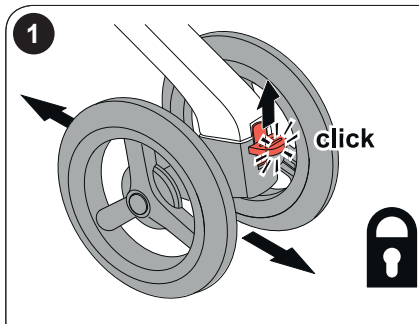

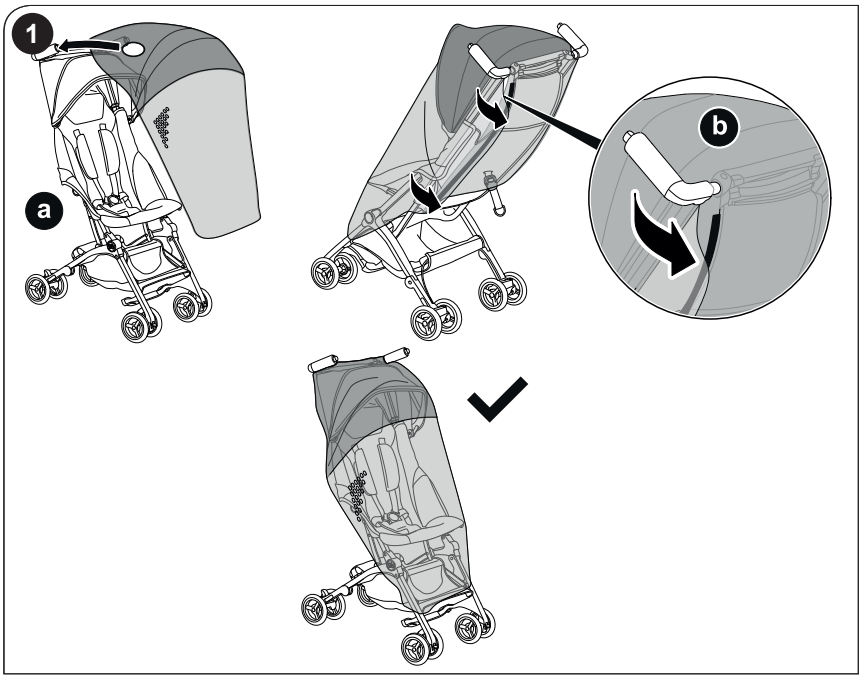

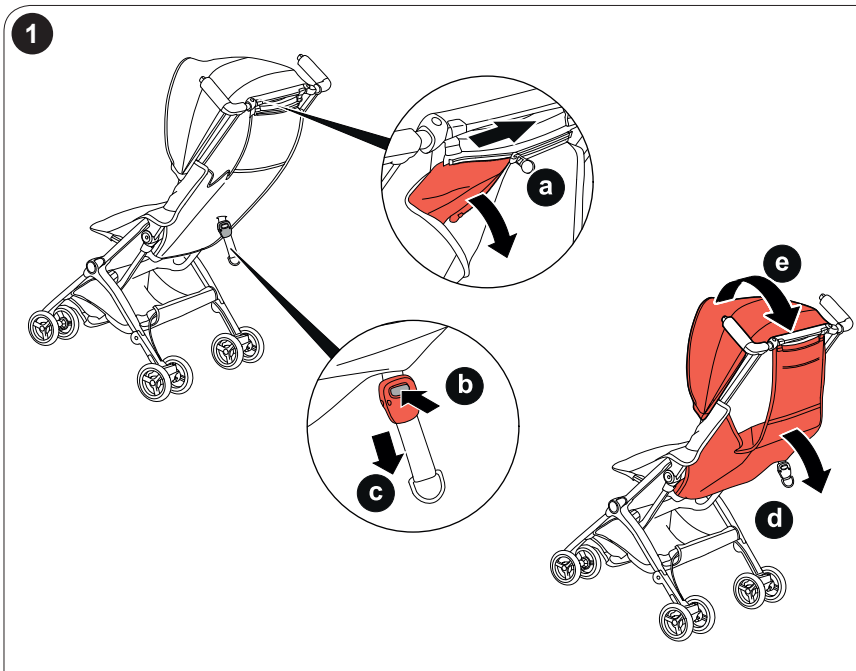

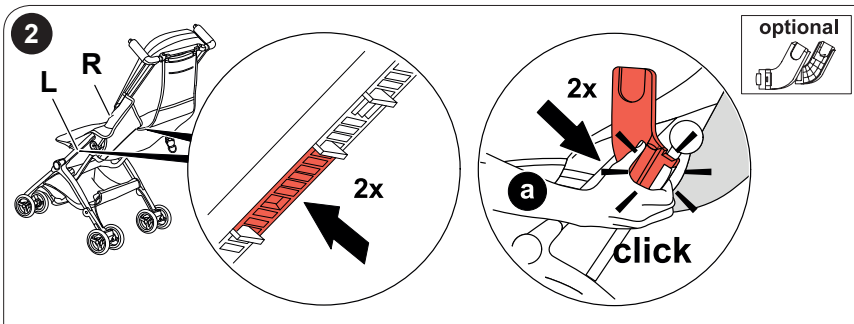

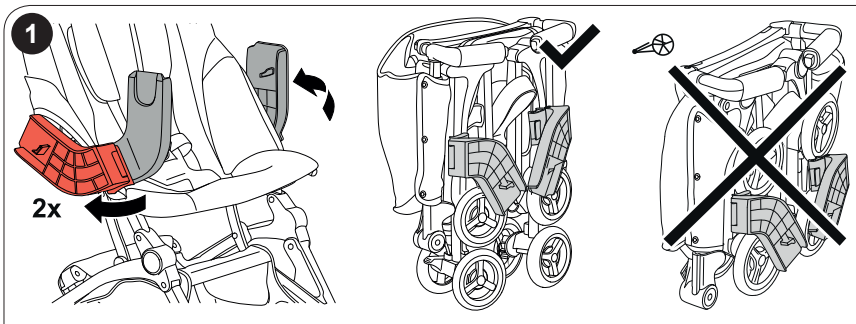

1

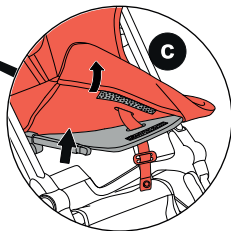
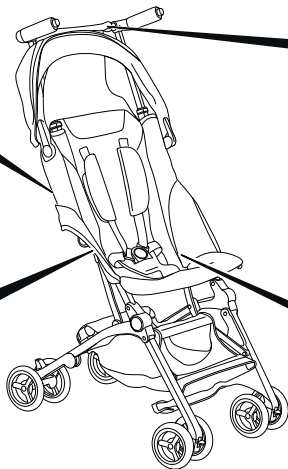
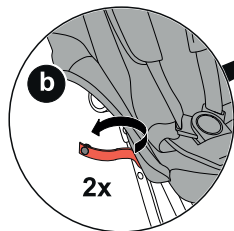
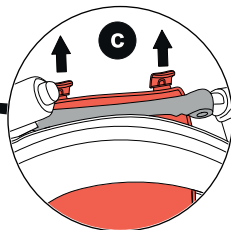
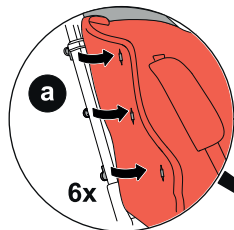



1

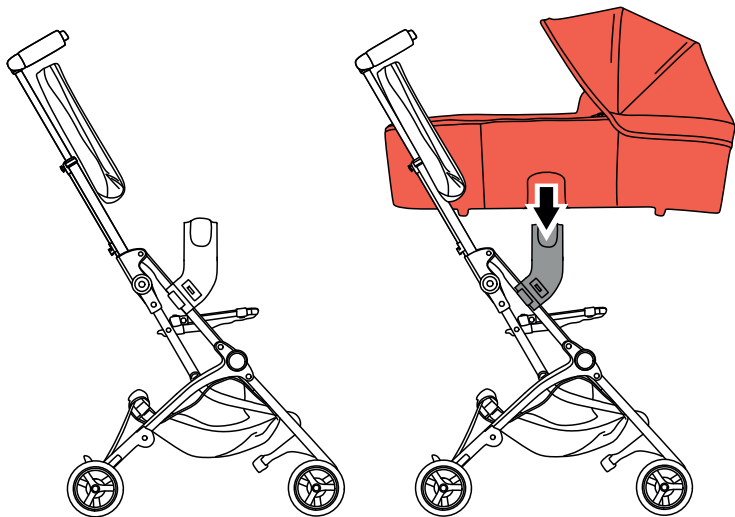



2

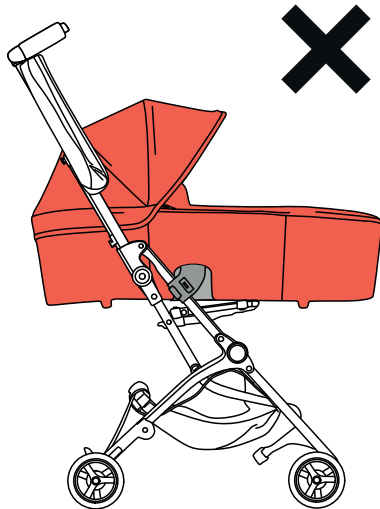
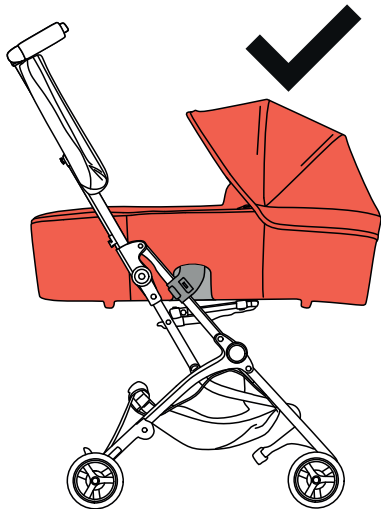

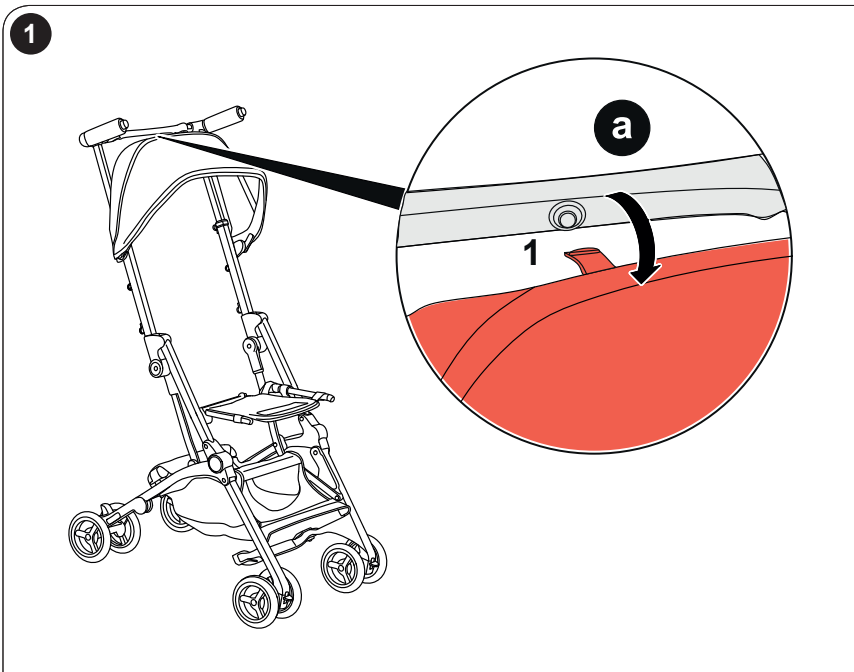

2

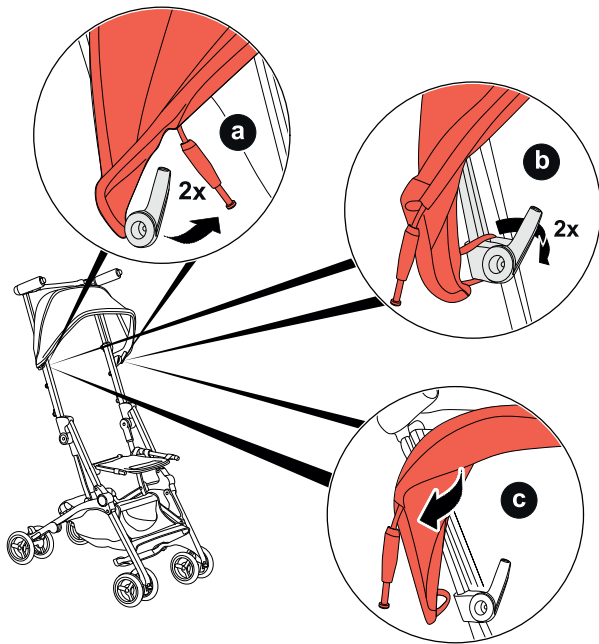

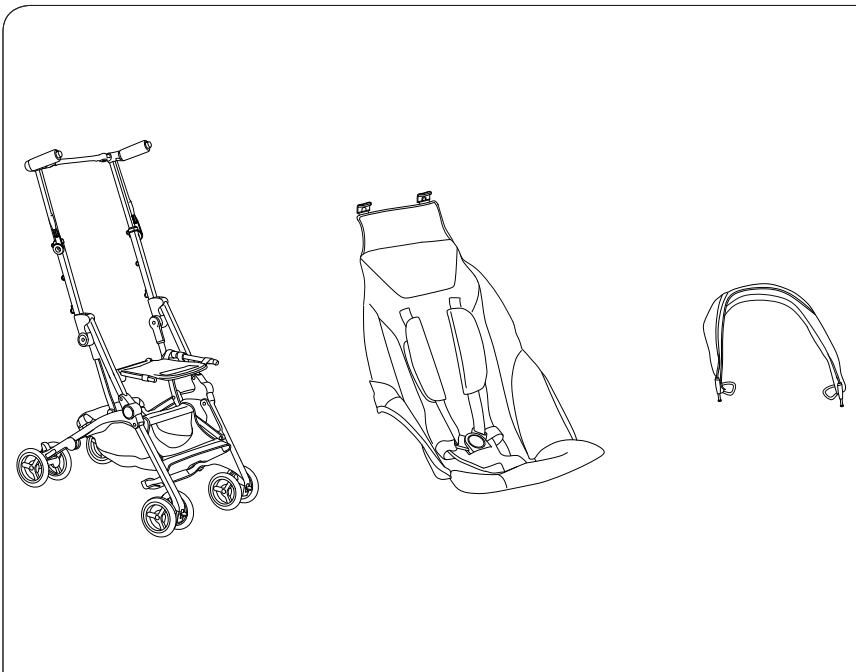



GOLD

CONTACT

EUROPE AND ASIA

gb GmbH
Riedingerstr 18
95448 Bayreuth
Germany
+49 (0) 921-78 511 - 0
info@gb-online.com

AUSTRALIA

CNP Brands
20 Calarco Drive, VIC, 3030
Australia
Customer Service 1300 667 137
info@cnpbrands.com.au

AMERICAS

Columbus Trading-Partners USA Inc.
560 Harrison Avenue
Suite 500
Boston, MA 02118
USA
Customer Service 1-844-543-2020
orders.us@columbustp.com

NEW ZEALAND

Wainhouse Distribution,
2-6 Argyle St, Morningside,
PO Box 41-014, St Lukes, Auckland
New Zealand
Customer Service: 0800 567 5000
helpline@wainhousedist.co.nz